

Interface Transceiver of the Serial Data of the Standard RS-485/RS-422

■ Description

The TK3085 is interface transceiver of serial data under RS-485 standard with low power consumption.

The TK3085 is purposed for application in telecom systems under RS485/RS422 standards with low power dissipation, translators of the level, transceiving devices sensitive to electromagnetic radiation, industrial control systems.

■ Features

- 1 transmitter and 1 receivers of the serial data of the standard RS-485
- Auto Shutdown function provide low power consumption
- Supply voltage range: $5.0V \pm 5\%$
- Operating temperature range: $-40 \sim +85^{\circ}\text{C}$
- Data rate: 0.5Mbps
- ESD protection up to 2000V for transmitter input and receiver output (TTL/CMOS levels) and up to 15000V for transmitter output and receiver input (RS-485 levels)
- Latch current, min – 300mA at normal climatic condition
- Enhanced ESD Specifications(EC&EE_ only):
 $\pm 15\text{kV}$ IEC61000-4-2 Air Discharge
 $\pm 8\text{kV}$ IEC61000-4-2 Contact Discharge

■ Ordering Information

Part Number	Package	Packing	Temperature(TA)	Package Qty	ESD
TK3085CSA	SOIC-8	Reel	$0^{\circ}\text{C} \sim 70^{\circ}\text{C}$	2500	
TK3085ESA	SOIC-8	Reel	$-40^{\circ}\text{C} \sim 85^{\circ}\text{C}$	2500	
TK3085ECSA	SOIC-8	Reel	$0^{\circ}\text{C} \sim 70^{\circ}\text{C}$	2500	$\pm 15\text{KV}$
TK3085EESA	SOIC-8	Reel	$-40^{\circ}\text{C} \sim 85^{\circ}\text{C}$	2500	$\pm 15\text{KV}$

■ Pin Description

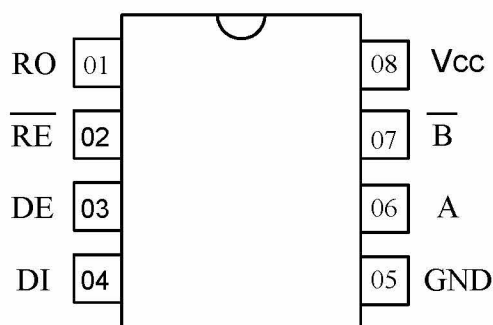

Figure 2

Table 1. Pin Description

Pin Number	Symbol	Pin Description
01	RO	TTL/CMOS Receiver data output
02	$\overline{\text{RE}}$	Receiver Output Enable.
03	DE	Transmitter Output Enable.
04	DI	Transmitter input
05	GND	Common pin
06	A	Noninverting receiver/transmitter input/output
07	$\overline{\text{B}}$	Inverting receiver/transmitter input/output
08	V _{CC}	Power supply

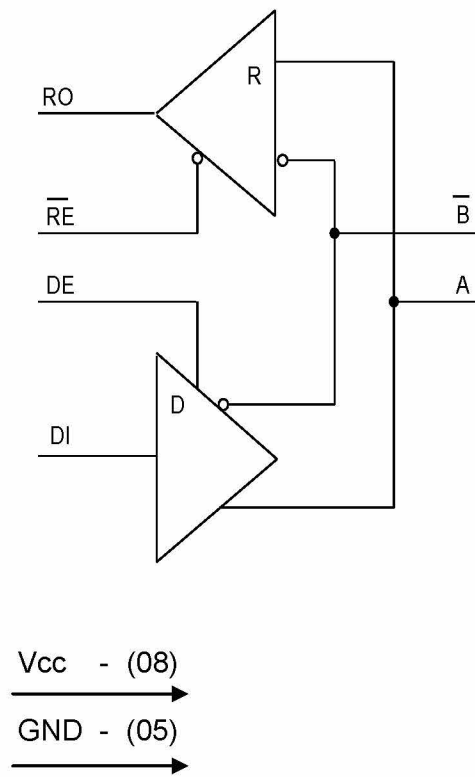

Figure 3. Block Diagram

Table 2. Transmitter Truth Table

Inputs			Outputs	
\overline{RE}	DE	DI	\overline{B}	A
X	H	H	L	H
X	H	L	H	L
L	L	X	Z	Z
H	L	X	ZZ	

Note : H – high level, L – low level , X –don't care, Z – third state

Table 3. Receiver Truth Table

Inputs			Outputs
\overline{RE}	DE	A, \overline{B}	RO
L	X	$\geq -0,05 B$	H
L	X	$\leq -0,2 B$	L
L	X	BH	H
H	H	X	Z
H	L	X	ZZ

Note : H – high level, L – low level , BH – inputs not used, X –don't care, Z – third state, ZZ – inputs and outputs are in the third state

Table 4. Recommended Operating Condition

Symbol	Parameter	Limit		Unit
		min	max	
V_{CC}	Supply voltage	4.75	5.25	V
V_{IL}	Input low voltage DI, DE, \overline{RE} pins	0	0.8	V
V_{IH}	Input high voltage DI, DE, \overline{RE} pins	2.0	V_{CC}	V
V_{OD}	Transmitter output voltage	-7.0	12.0	V
V_{IR}	Receiver input voltage	-7.0	12.0	V
V_{OR}	Receiver output voltage	0	V_{CC}	V
V_{TH}	Receiver differential threshold voltage	$ \pm 50 $	$ \pm 200 $	V
T	Ambient temperature	-40	85	°C

Table 5. Maximum Ratings

Symbol	Parameter	Limit		Unit
		min	max	
V_{CC}	Supply voltage	-	7.0	V
V_{IL}	Input voltage on pins DI, DE, \overline{RE}	-0.3	7.0	V
V_{OD}	Transmitter output voltage	-13	13	V
V_{IR}	Receiver input voltage	-13	13	V
V_{OR}	Receiver output voltage	-0.3	$V_{CC}+0.3$	V

* Stresses beyond those listed under "maximum ratings" may cause permanent damage to the device. These are stress ratings only and functional operation of the device at these or any other conditions beyond those indicated under "recommended operating conditions" is not implied. Exposure to absolute-maximum-rated conditions for extended periods may affect device reliability.

Table 6. Electrical Parameters
 (V_{CC} = 5V ± 5%)

Symbol	Parameter	Mode	Limit		T _A , °C	Unit
			Min	Max		
I _{CC}	Idle mode supply current	V _{RE} = 0 B or V _{CC} V _{DI} = 0 B or V _{CC} V _{DE} = V _{CC}	-	800	25 ± 10	μA
		900		-40; 85		
I _{SHDN}	Shutdown mode supply current	V _{RE} = 0 V V _{DI} = 0 V or V _{CC} V _{DE} = 0	-	500	25 ± 10	μA
		600		-40; 85		
I _{SHDN}	Shutdown mode supply current	V _{DE} = 0V V _{RE} = V _{CC}	-	9.0	25 ± 10	μA
		10		-40; 85		
I _{ILL}	Input low leakage current on control pin	V _{DE} = V _{DI} = V _{RE} = 0 V	-	-0.2	25 ± 10	μA
		-2.0		-40; 85		
I _{ILH}	Input high leakage current on control pin	V _{DE} = V _{DI} = V _{RE} = V _{CC}	-	0.2	25 ± 10	μA
		2.0		-40; 85		
t _{SHDN}	Shutdown time	-	50	600	25 ± 10	ns
Receiver						
V _{OLR}	Output low voltage	V _{ID} = -200 mV I _{OL} = 4.0 mA	-	0.36	25 ± 10	V
		0.4		-40; 85		
V _{OHR}	Output high voltage	V _{ID} = -50 mV I _{OH} = -4.0 mA	V _{CC} - 1.5	-	25 ± 10; -40; 85	V
		-		-40; 85		
R _I	Input resistance	-7.0 V ≤ V _{IR} ≤ 12 V	96	-	25 ± 10; -40; 85	kΩ
I _I	Input current	V _{IR} = 12 V	-	114	25 ± 10	μA
		V _{IR} = -7.0 V		-66	-40; 85	
		V _{IR} = 12 V		125		
		V _{IR} = -7.0 V		-75		
I _{OZLR}	Output low current for OFF-state	V _{OR} = 0.4 V	-	-0.5	25 ± 10	μA
		-1.0		-40; 85		
I _{OZHR}	Output high current for OFF-state	V _{OR} = 2.4 V	-	0.5	25 ± 10	μA
		1.0		-40; 85		

Table 6. Electrical Parameters (continued)

Symbol	Parameter	Mode	Limit		T _A , °C	Unit
			Min	Max		
Receiver						
I _{OSHR}	Output high short circuit current	V _{OR} = V _{CC}	8.0	87	25 ± 10	mA
			7.0	95	-40; 85	
I _{OSLR}	Output low short circuit current	V _{OR} = 0 V	-8.0	-87	25 ± 10	mA
			-7.0	-95	-40; 85	
V _{hR}	Hysteresis	–	–	50	25 ± 10	mV
t _{PHLR} , t _{PLHR}	Receiver input to output switching delay	V _{ID} ≥ 2.0 V t _{LH} = t _{HL} ≤ 15 ns	–	185	25 ± 10	ns
				200	-40; 85	
t _{SKDR}	Differential receiver skew	V _{ID} ≥ 2.0 V t _{LH} = t _{HL} ≤ 15 ns	–	28	25 ± 10	ns
				30	-40; 85	
t _{PZHR} , t _{PZLR}	Receiver enable from OFF to output high (low)	C _L = 100 pF	–	45	25 ± 10	ns
				50	-40; 85	
t _{LR (SHDN)} , t _{HR (SHDN)}	Receiver enable from shutdown to output high (low)	C _L = 100 pF	–	3150	25 ± 10	ns
				3500	-40; 85	
Transmitter						
V _{OD1}	Differential output voltage (no load)	–	5.0	–	25 ± 10; -40; 85	V
V _{OD2}	Differential output voltage (no load)	R _L = 50 Ω (RS-422)	2.08	–	25 ± 10	V
			2.00	–	-40; 85	
		R _L = 27 Ω (RS-485)	1.56	–	25 ± 10	
			1.50	–	-40; 85	
ΔV _{OD}	Change in magnitude of differential output voltage for complementary output states	R _L = 50; 27 Ω	–	0.18	25 ± 10	V
				0.2	-40; 85	
V _{OC}	Output bias voltage refer to common pin	R _L = 50; 27 Ω	–	2.9	25 ± 10	V
				3.0	-40; 85	
ΔV _{OC}	Change in magnitude of bias output voltage for complementary output states	R _L = 50; 27 Ω	–	0.18	25 ± 10	V
				0.20	-40; 85	

Table 6. Electrical Parameters (continued)

Symbol	Parameter	Mode	Limit		T _A , °C	Unit
			Min	Max		
Transmitter						
I _{OSD}	Short circuit current	- 7.0 V ≤ V _{OD} ≤ V _{CC}	-	±240	25 ± 10	mA
				±250	-40; 85	
		0 V ≤ V _{OD} ≤ 12 V		240	25 ± 10	
				250	-40; 85	
		0 V ≤ V _{OD} ≤ V _{CC}		±26	25 ± 10	
			±25	-40; 85		
V _{hD}	Hysteresis	-	-	200	25±10	V
t _{P_{HL}D} , t _{P_{LH}D}	Transmitter input to output switching delay	C _{L1} = C _{L2} = 100 pF R _{DIFF} = 54 Ω	330	800	25 ± 10	ns
			250	1000	-40; 85	
t _{SKEW D}	Transmitter output skew	C _{L1} = C _{L2} = 100 pF R _{DIFF} = 54 Ω	-	90	25 ± 10	ns
				100	-40; 85	
t _{P_{ZH}D} , t _{P_{ZL}D}	Transmitter enable time from OFF to output high (low)	C _L = 100 pF	-	2200	25 ± 10	ns
				2500	-40; 85	
t _{P_{HZ}D} , t _{P_{LZ}D}	Transmitter disable time from output high (low) to OFF	C _L = 15 pF	-	90	25 ± 10	ns
				100	-40; 85	
t _{RD} , t _{FD}	Rise or fall time of differential output signal	R _{DIFF} = 54 Ω C _{L1} = C _{L2} = 100 pF	220	620	25 ± 10	ns
			200	750	-40; 85	
t _{LD (SHDN)} , t _{HD (SHDN)}	Transmitter enable time from shutdown to output high (low)	C _L = 15 pF	-	4000	25 ± 10	ns
				4500	-40; 85	
ST	Data rate	-	600	-	25 ± 10	Kb/s
			500		-40; 85	

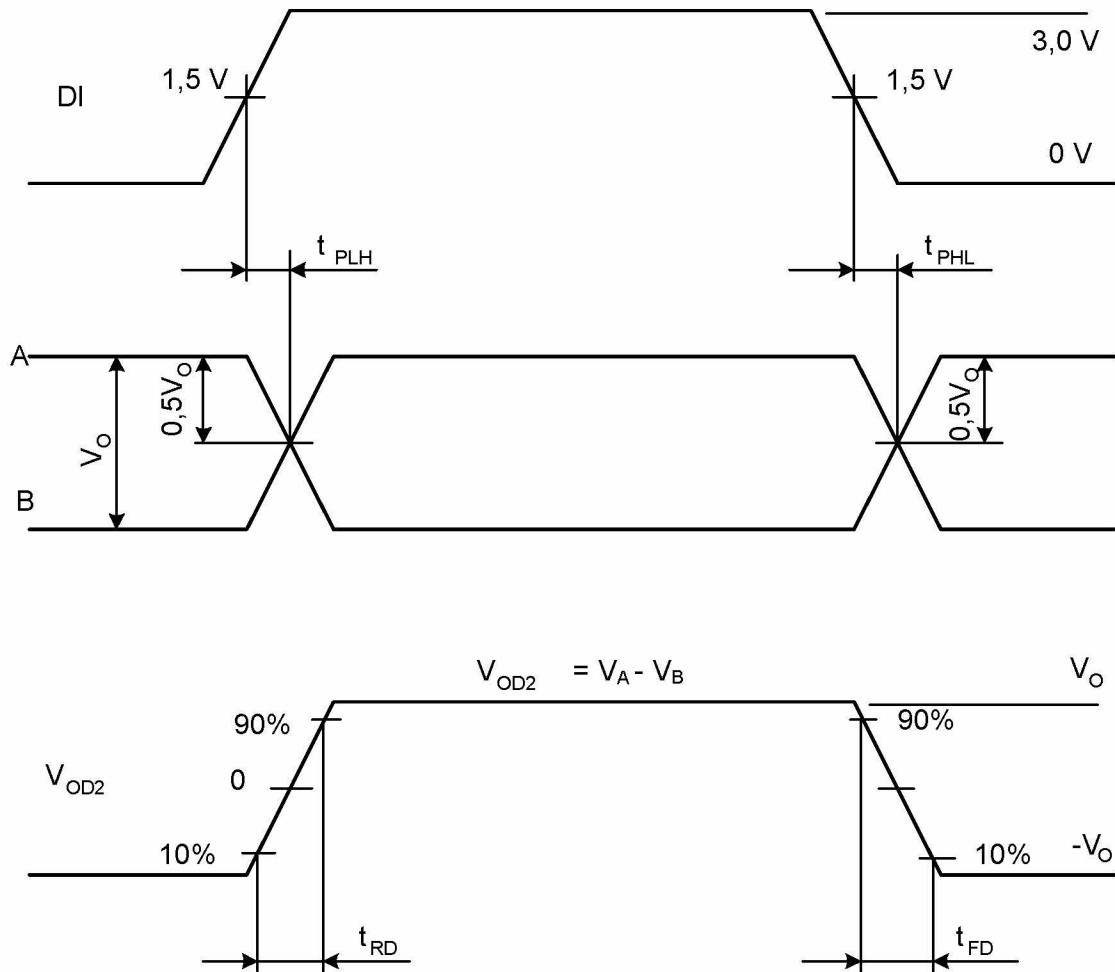
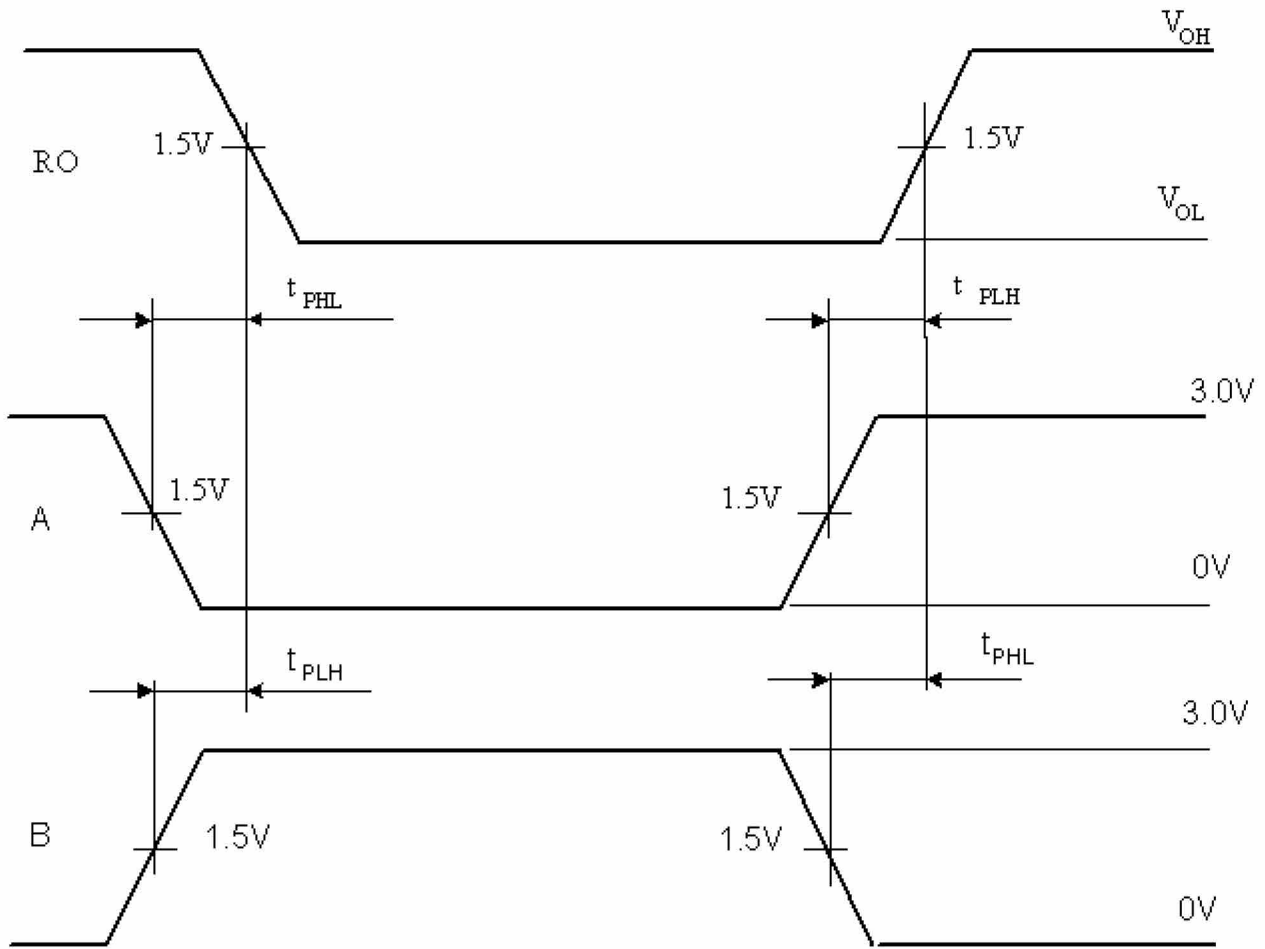

Figure 4. Transmitter output & input signals time diagram



During the input signal A is changing DC voltage 1.5 V is supplied to input B
 During the input signal B is changing DC voltage 1.5 V is supplied to input A

Figure 5. Receiver output & input signals time diagram

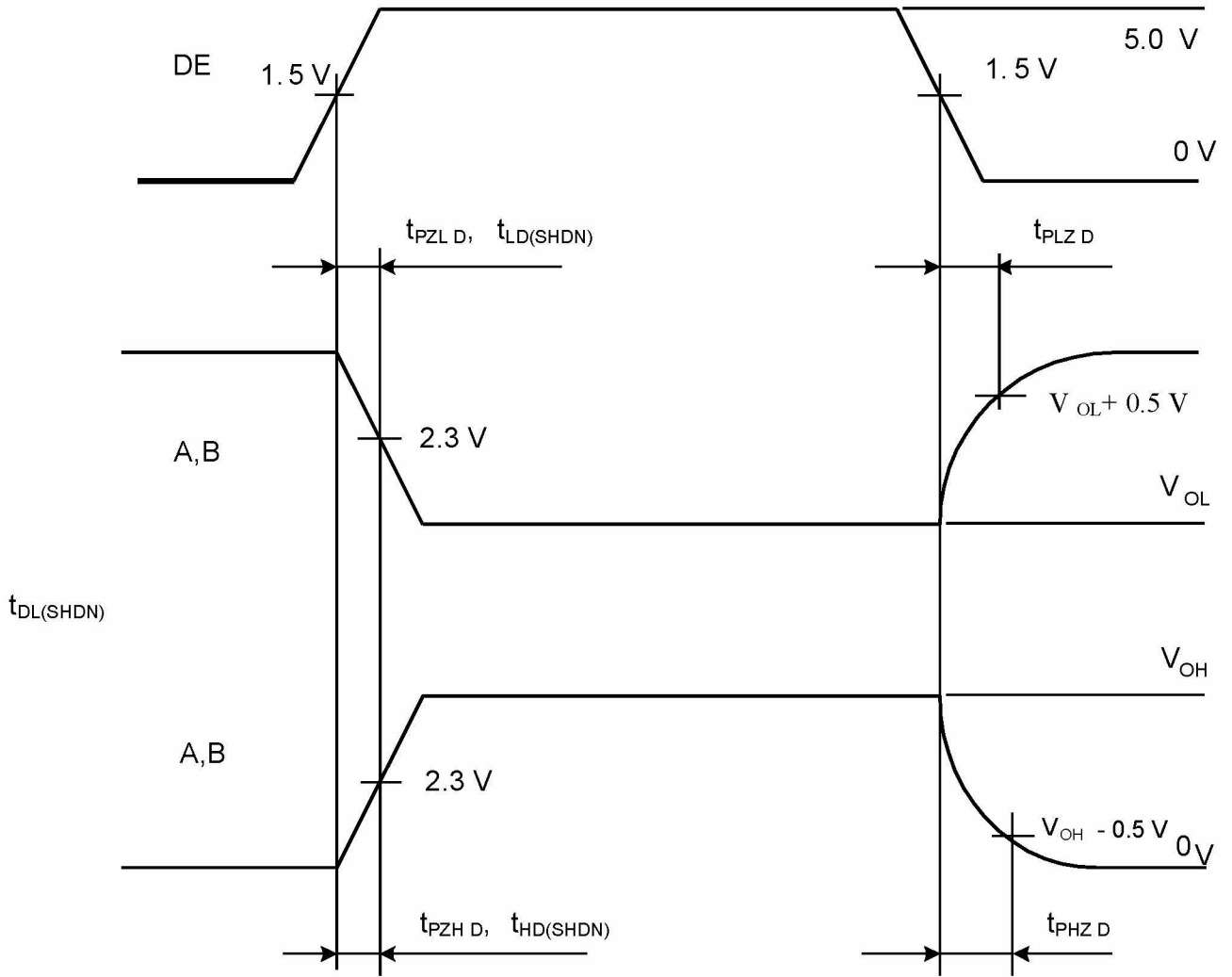

Figure 6. Transmitter output & input signals time diagram

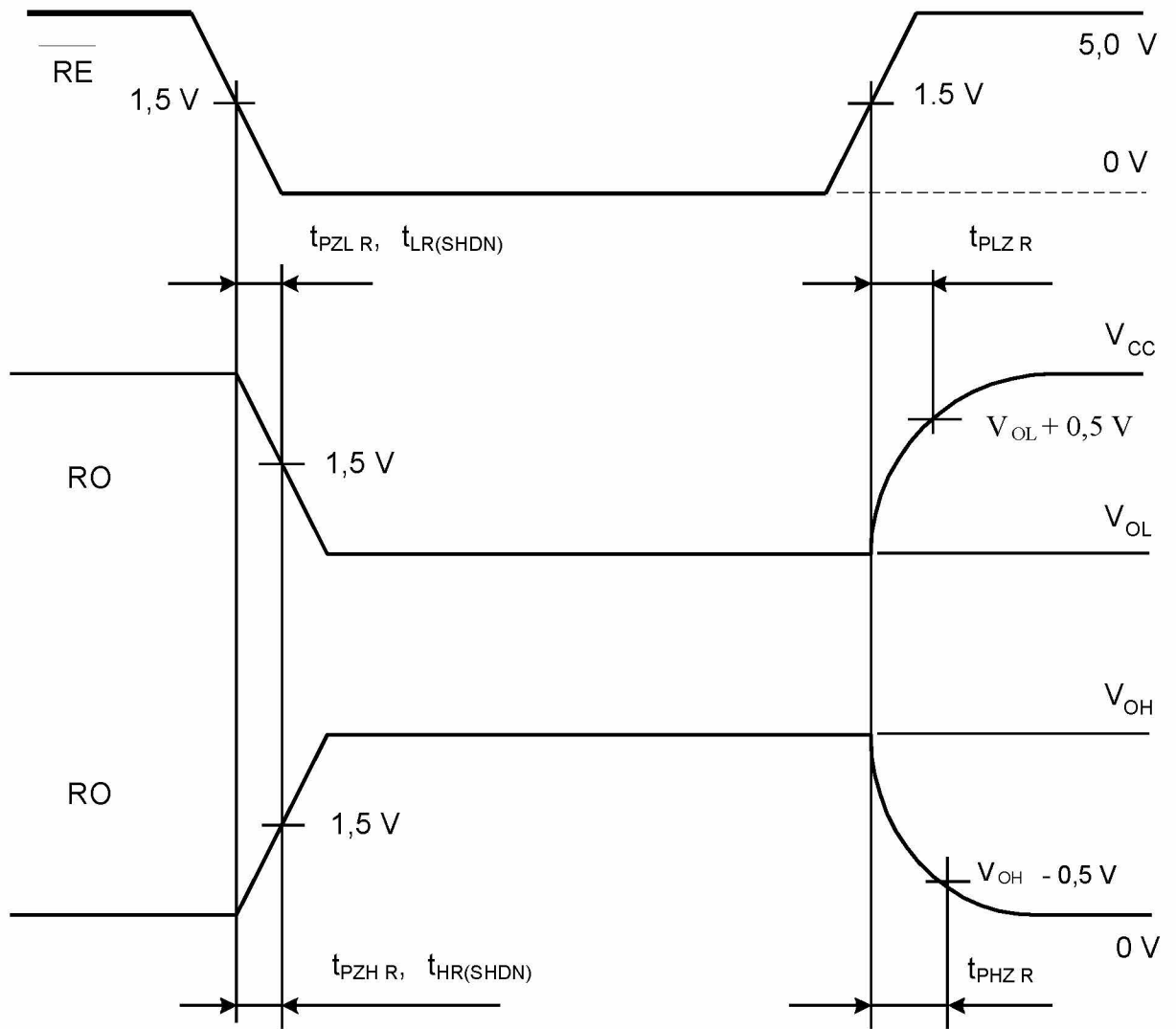
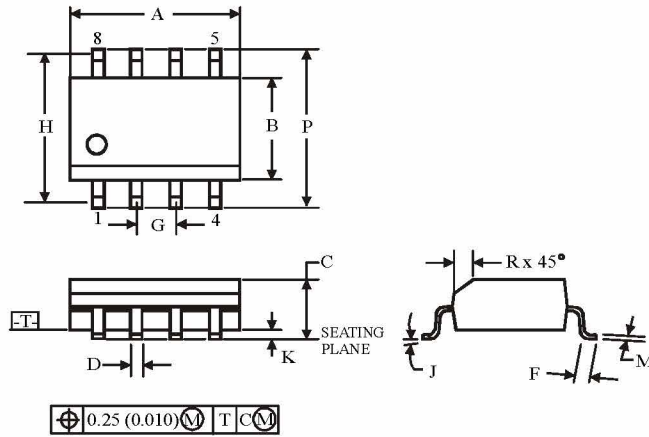

Figure 7. Receiver output & input signals time diagram

■ Package Dimensions
SOIC8

Symbol	Dimension, mm	
	MIN	MAX
A	4.8	5
B	3.8	4
C	1.35	1.75
D	0.33	0.51
F	0.4	1.27
G	1.27	
H	5.72	
J	0°	8°
K	0.1	0.25
M	0.19	0.25
P	5.8	6.2
R	0.25	0.5

NOTES:

1. Dimensions A and B do not include mold flash or protrusion.
2. Maximum mold flash or protrusion 0.15 mm (0.006) per side for A; for B - 0.25 mm (0.010) per side.